



6-19-210-82

( )



Ø 325 ÷ 1420 , . . .

200 ÷ 250 ;  
2 ÷ 3 ;

/		,	, /	./ , <sup>3</sup>		1
1.	-1420	1420	0,10	8,0/32÷35	4	40-50
2.	-1220	1220	0,098	6,0/14	2	80-100
3.	-1020	1020	0,077	5,0/12	2	50
4.	-820	820	0,074	4,6/11	2	50
5.	-720	720	0,071	4,0/9,6	2	50
6.	-530	530	0,063	3,5	1	100
7.	-377	325-426	0,058	1,4	1	25-40

“ ”

/ : +7(495)6413158, +7(495)6413159, e-mail: npoalfa@mail.ru

( )



219-1420

200 - 250

( )

			<sup>3</sup> / -	/ -	/ -	(1 b),	
-1400	1420		3,5±0,1	5,3 ±0,2	3,5 ±0,2	1,6 3,2	102-588-91
-1200	1220	— « —	3,5±0,1	5,3 ±0,2	3,5 ±0,2	1,6 2,8	102-588-91
1000	1020	— « —	3,5±0,1	5.3 ± 0,2	3,5 ±0,2	1,6 2,6	102-588-91
-800	630-820	— « —	2,4±0,1	3,8 ±0,2	2,4 ±0,1	1,6 2,1÷2,3	102-592-91
-500	377-530	— « —	1,2±0,1	1,8 ±0,1	1,2 ±0,1	1,2 1,3	102-593-91
-300	219-325	— « —	0,5±0,1	0,7 ±0,1	0,5 ±0,1	1,0 1,1	102-590-91

“ ”

/ : +7(495)6413158, +7(495)6413159, e-mail: npoalfa@mail.ru

( )

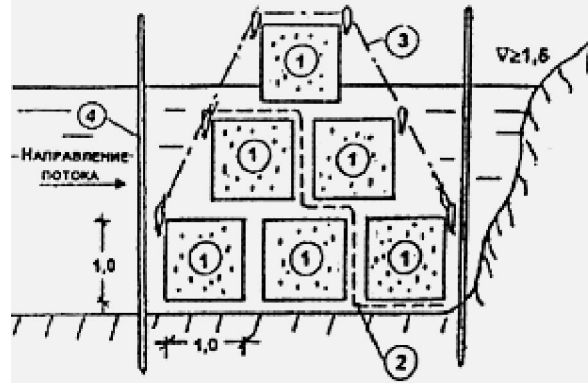
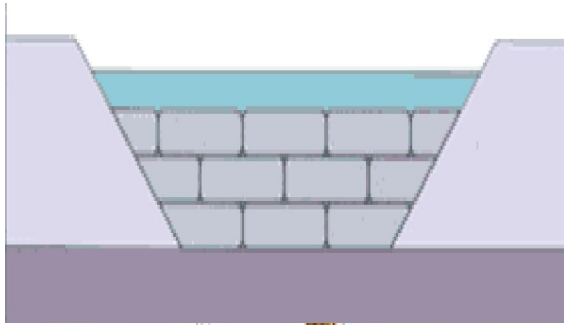

8397 – 021 – 01297858 – – 97

	50							
) (	6							
	0,03 - 4,0 <sup>3</sup>							
	-0,05	-0,1	-0,2	-0,4	-0,8	-1,8	-2,5	-5,5
	0,05	0,09	0,22	0,42	0,75	1,75	2,5	5,5

“ ”

/ : +7(495)6413158, +7(495)6413159, e-mail: npoalfa@mail.ru

(

)

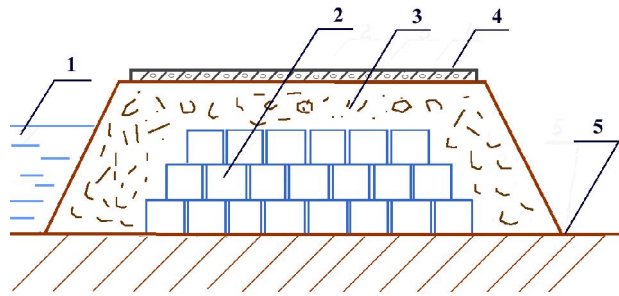

- 1.
- 2.
- 3.
- 4.
- 5.

/		
1.		
2.		50
3.	) (	6
4.		0,03 - 4,0 <sup>3</sup>

“

”

/ : +7(495)6413158, +7(495)6413159, e-mail: npoalfa@mail.ru



( )  
 ( 1,0 )

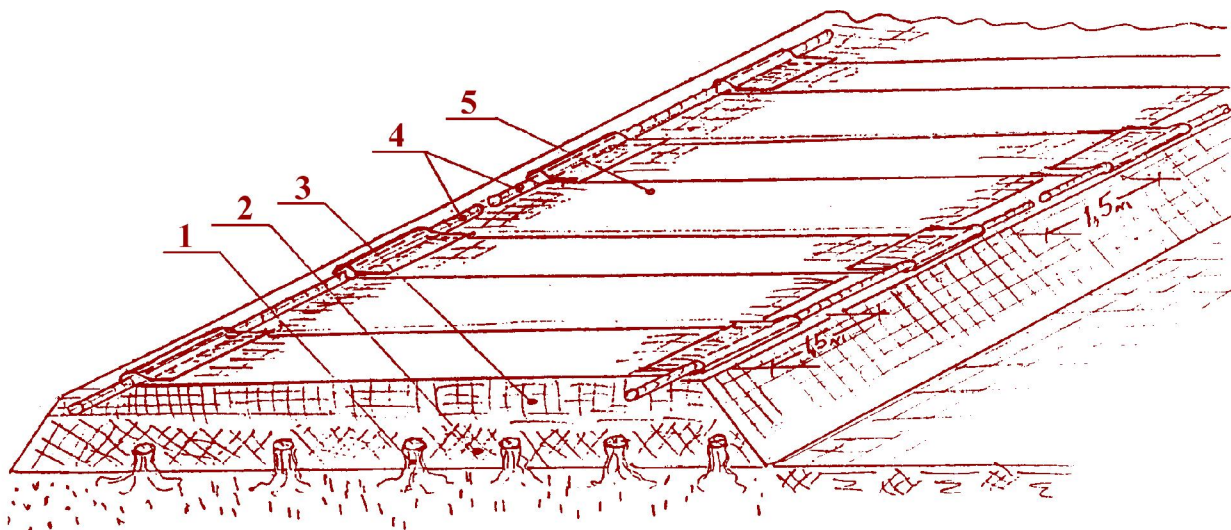

- 1. : :
- 2. 15 - 20
- 3. .
- 4. .
- 5. ( 1)

- 1.  $\geq$
- 2. 7 / .
- 3. - 14 / .
- 4.  $\geq 20,0$  / .
- 5.  $\geq 30$  .

“ ”  
 / : +7(495)6413158, +7(495)6413159, e-mail: npoalfa@mail.ru

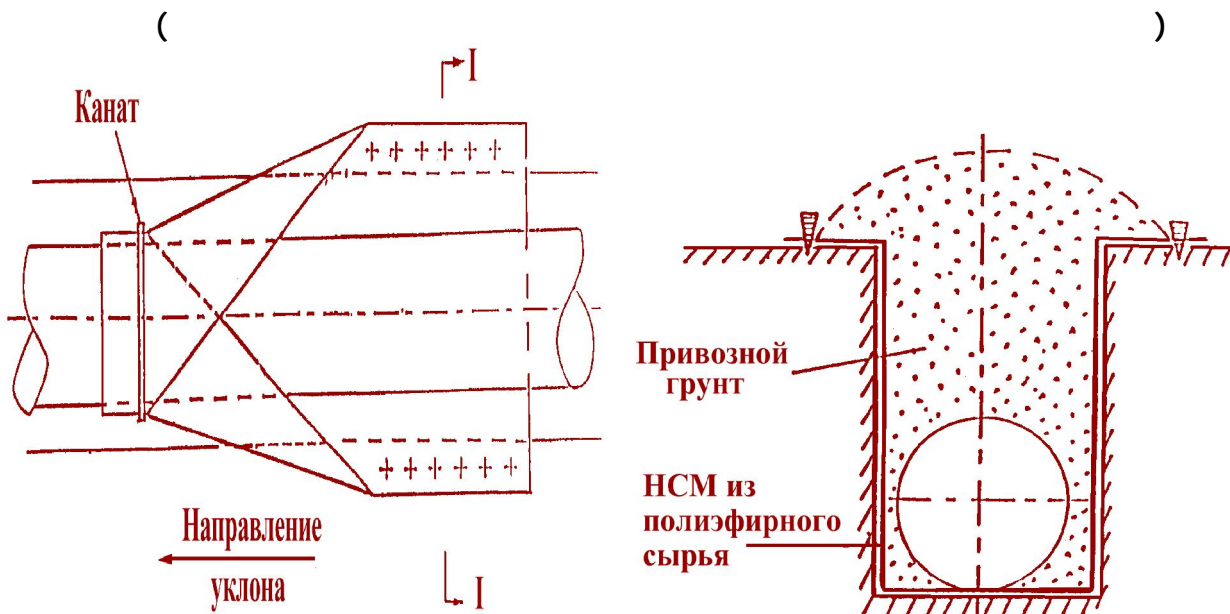

85 0113-020-01297858-99.

-1420	7200 ± 100	11000 ±100	40,0 ± 2,5
-1220	6000 ± 100	9000 ±100	32,0 ± 2,0
-1020	6000 ± 100	8000 ±100	28,0 ± 2,0
-820	4800 ± 100	7000 ±100	20,0 ±1,5
-720	4800 ± 100	7000 ± 100	20,0 ±1,5
-530	3600 ± 100	6000 ±100	16,0± 1,0
-430	3600 ± 100	5000 ± 100	12,0 ±0,5
-325	3600 ± 100	5000 ±100	12,0 ±0,5

“ ”

/ : +7(495)6413158, +7(495)6413159, e-mail: npoalfa@mail.ru

( )

-40° +40° .



1. \_\_\_\_\_ :
2. ( )
3. \_\_\_\_\_
4. \_\_\_\_\_

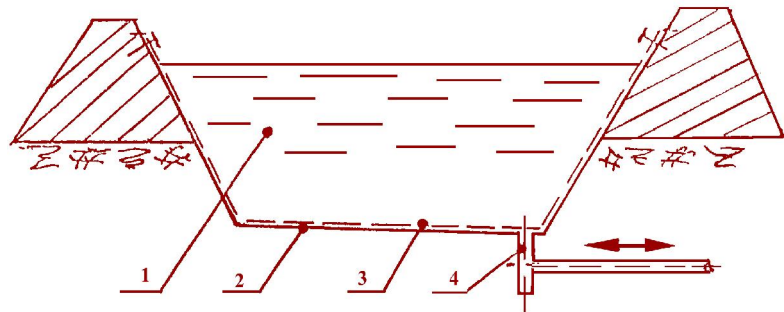

1. \_\_\_\_\_ :
2. \_\_\_\_\_
3. \_\_\_\_\_
4. \_\_\_\_\_
5. \_\_\_\_\_ :

- ≥100 ( )

- \_\_\_\_\_ 5 .
- \_\_\_\_\_ 50 .

	1000	-500	-400	-300	-250	-200	-100	-75	50	-25
, <sup>3</sup>	1000	500	400	300	250	200	100	75	50	25
,	1000	600	500	400	320	280	200	150	100	65
,	20 40	20 30	20 25	20 20	20 16	20 14	20 10	20 7,5	10 10	8 8

“ ”

/ : +7(495)6413158, +7(495)6413159, e-mail: npoalfa@mail.ru



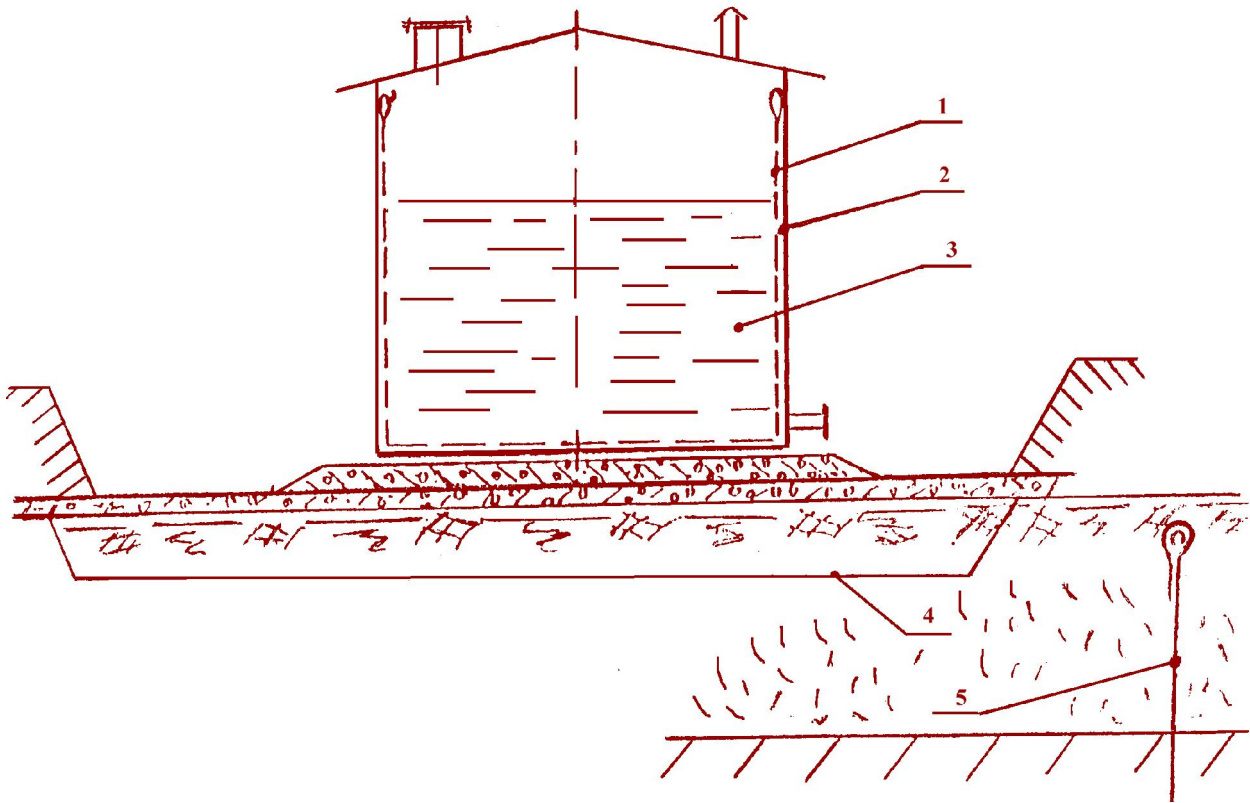

1. :
  2. ( )
  3. " "
  4. " "
  5. " "
1. > 5 , - 50
2. - 0,9 ± 0,05 / 2
3. ( ) , "
4. " - , "

“ ”  
/ : +7(495)6413158, +7(495)6413159, e-mail: npoalfa@mail.ru

48-3488-012-01297858-98

530 - 1420

-1 -  
-2 -

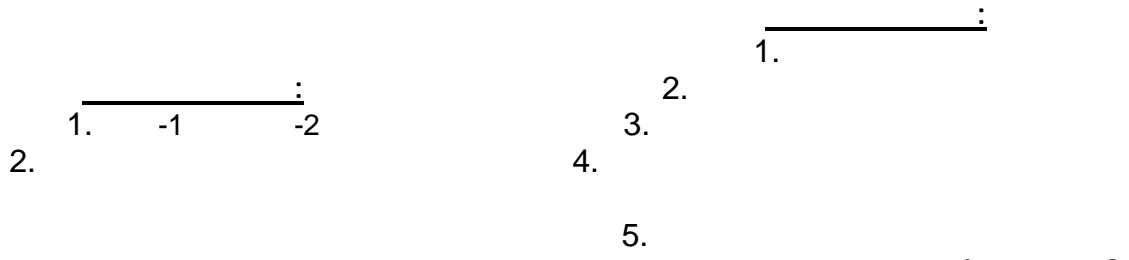
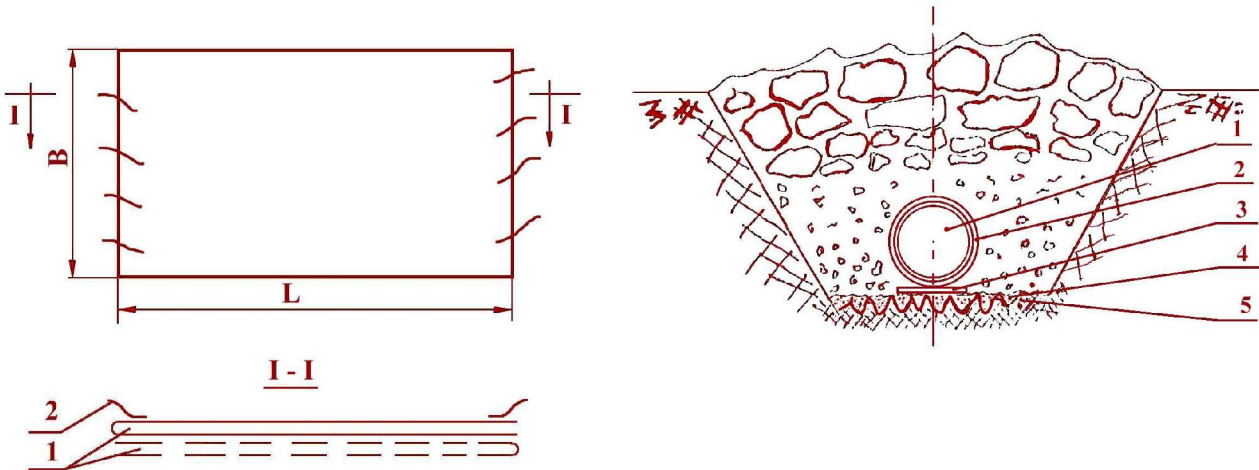

		(L)	(B)	1 -1/	2 -2
-1-1420/	-2-1420	4400±20	2400±20	1101±0,5/22,0±0,5	5
-1-1220/	-2-1220	3800±20	2400±20	9,5±0,5/19,0±0,5	
-1-1020/	-2-1020	3150±20	2400±20	7,9±0,5/15,8±0,5	
-1-820/	-2-820	2500±20	2400±20	6,25	±0,5/12,5±0,5
-1-720/	-2-720	2200±20	2400±20	5,5±0,5/11,0±0,5	
-1-630/	-2-630	1950±20	2400±20	5,0 ±0,5/10,0±0,5	
-1-530/	-2-530	1650±20	2400±20	4,0±0,5/8,0±0,5	

“ ”  
/ : +7(495)6413158, +7(495)6413159, e-mail: npoalfa@mail.ru

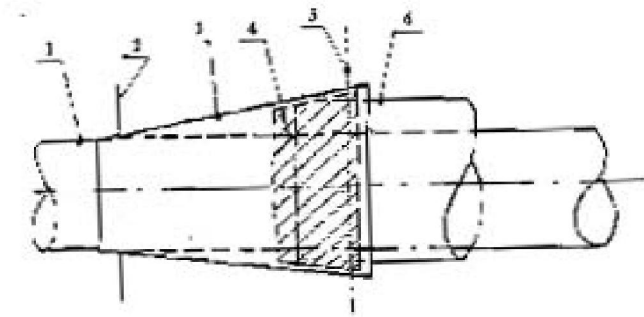

1. \_\_\_\_\_;
- 2.
- 3.
4. ( )
- 5.
- 6.

« -2» 8713-076—00300179-01

• - ( );  
 • - ( ).



t° -40° +50° .

( )	1400-1700		1400-1600	1200-1600	1200-1400	1000-1400	1000-1200		800-1200	800-1000	700-1000
,	950		800	850	800	800	800		750	600	650
,	350		350	350	350	350	350		350	300	300
( )	600-1000	500-800	500-700	400-600	370-700	370-600	300-500	270-500	200-400	150-370	100-300
,	650	550	500	500	500	500	450	500	400	400	400
,	300	250	250	250	250	250	250	250	200	200	200

1400 - ( ) 1400-1700  
 1420 ; 1700 - 1720

“ ”  
 / : +7(495)6413158, +7(495)6413159, e-mail: npoalfa@mail.ru

1.

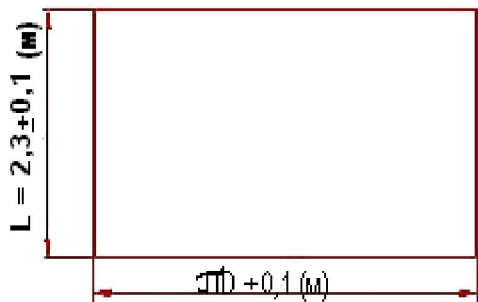

2.

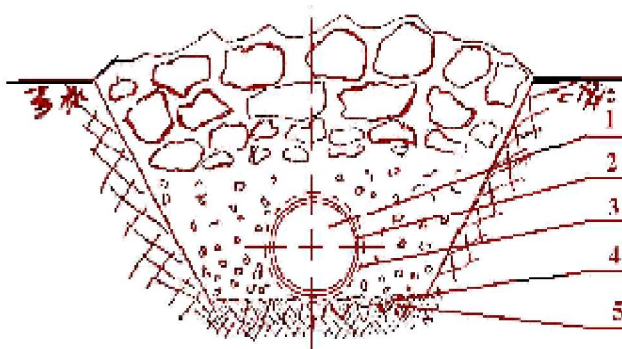

L - длина скального листа вдоль трубопровода  
D - диаметр трубопровода

- 1.
- 2.
- 3.
- 4.
- 5.

( )

70

| 83 97-019-

01297858- 1-99/

1.	1 <sup>2</sup> , - - 10	3,85 ± 0,2 3,30 ± 0,1	7,6 ± 0,4 6,5 ± 0,2
2.	,	45	120
3.	50 200 , , ( /	160	240
4.	, %	20	20
5.	,	3,5 ± 0,5	7 ± 1



1469-001-01297858-98



10 /  
120 / 2

<b>108</b>	<b>3,0</b>	<b>6</b>	<b>5</b>
<b>159</b>	<b>4,3</b>	<b>6</b>	<b>5</b>
<b>219</b>	<b>5,2</b>	<b>6</b>	<b>5</b>
<b>273</b>	<b>5,5</b>	<b>6</b>	<b>5</b>
<b>325</b>	<b>6,0</b>	<b>6</b>	<b>5</b>
<b>377</b>	<b>7,0</b>	<b>6</b>	<b>5</b>
<b>426</b>	<b>9,0</b>	<b>6</b>	<b>5</b>
<b>530</b>	<b>10,0</b>	<b>5</b>	<b>4,5</b>
<b>720</b>	<b>15,0</b>	<b>5</b>	<b>4,5</b>
<b>820</b>	<b>17,0</b>	<b>5</b>	<b>4,5</b>
<b>1020</b>	<b>24,0</b>	<b>4</b>	<b>3,5</b>
<b>1066</b>	<b>23,0</b>	<b>4</b>	<b>3,5</b>
<b>1220</b>	<b>30,0</b>	<b>4</b>	<b>3,5</b>
<b>1420</b>	<b>36,0</b>	<b>4</b>	<b>3,5</b>

“ ”

/ : +7(495)6413158, +7(495)6413159, e-mail: npoalfa@mail.ru

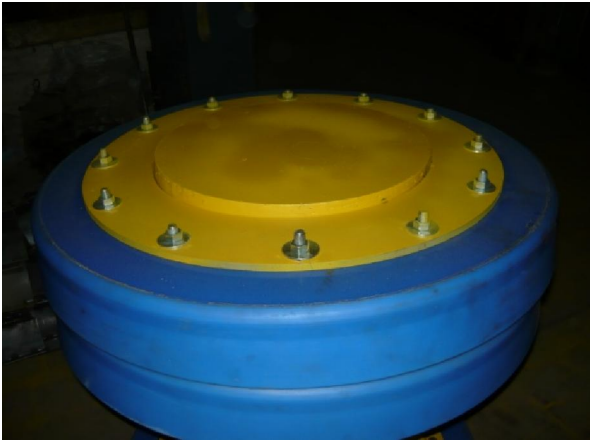

;

1) ( ),

2) / ;

3) ,